



SINOLTECH ENERGY LIMITED

SHANDONG SINOLTECH INTERNATIONAL CO., LTD



SINOLTECH

SPLIT DESIGN . DELICATE. SUPERIOR QUALITY

ELITE SPLIT SOLAR STREET LIGHT

5 Years Product Warranty

ELITE SERIES SPLIT SOLAR LIGHT

50W

Model No.: G02-50W

General information:

Based on the stable electronical circuit of traditional integrated solar street light and semi-integrated solar street light, the Solar Light is upgraded and developed by our senior ID, Mechanical, Software and Hardware engineers. Bidirectional rotatable solar panel, light without mechanical switch, mobile APP bluetooth remote control and convenient installation can meet the philosophy of PV industry perfectly --- Safety, Eco-friendly and Intelligent Application.

Product overview:

1. Product introduction: As a outdoor lighting fixture, the Solar Light is powered by solar energy and designed to offer outstanding quality by utilizing A-class LED beads, integrated optical LED lens, high efficiency mono solar panel, powerful lithium battery, self-developed developed MPPT controller and patent bluetooth APP system.
2. Operation principle: The Solar Light is a revolutionary product by utilizing Photovoltaic effect. It is designed to constantly absorb solar energy in daylight and convert to electricity, the intelligent controller could precisely control the charge, discharge and well preserve electricity into the lithium battery. And start to illuminate, which is powered by the lithium battery, once the illuminance of ground reduced to 15 lux in nighttime, or solar panel voltage drop to 5V below. The intelligent controller not only protects the battery from over-charging, over-discharging, but also can control the light switch-on, the time of switch-on and optimize the brightness effectively according to the real-time environment.

Product features

1. Product structures

The Solar Light with streamlined design is manufactured with an Exclusive Private Mold and made of Aluminum Die Casting.

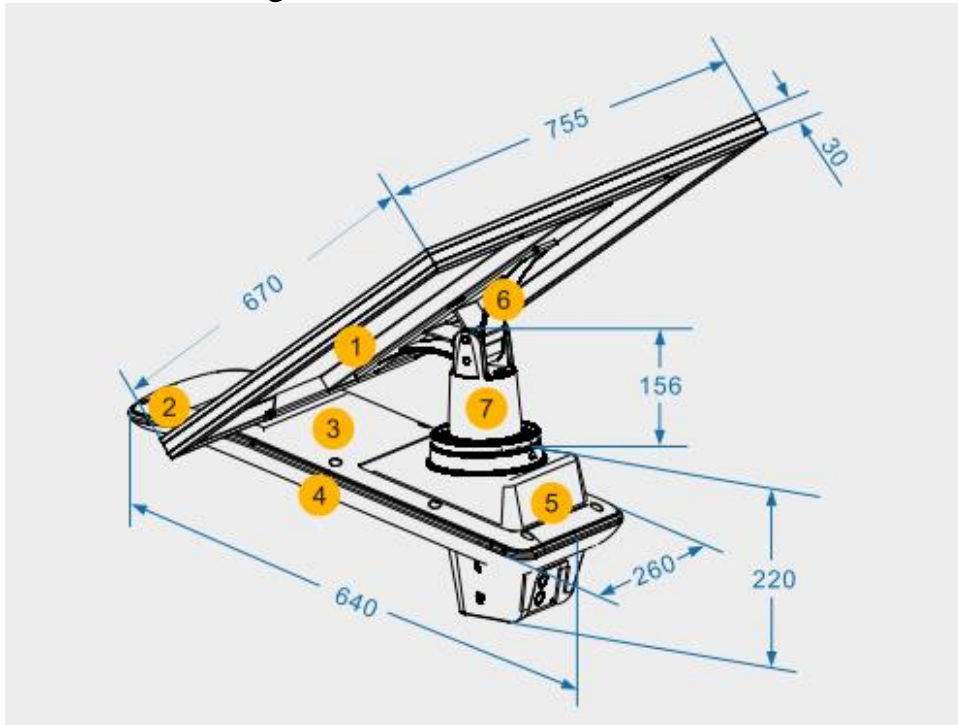

1.Solar Panel 2. Microwave/PIR Sensor 3. MPPT Controller 4. LED Source 5. Lithium Battery 6. Horizontal Bracket 7. Vertical Bracket

2.Function Characteristic

① Solar panel could be rotated 360° horizontally and 240° vertically, which will increase the photoelectronical conversion maximum in different areas; customized solar panel is available

Rotated 360° horizontally

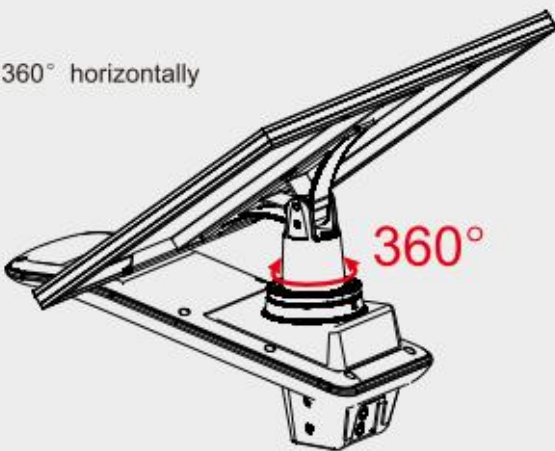

Rotated 240° vertically

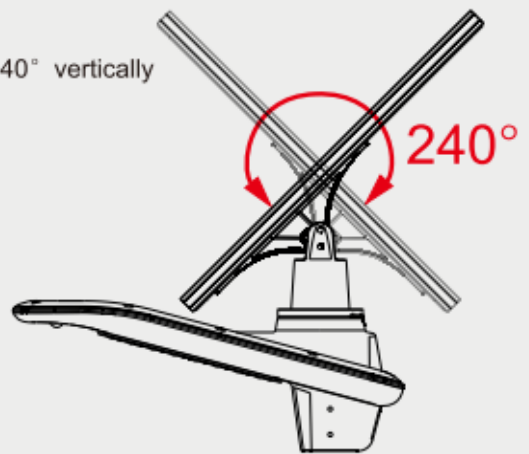

② The integrated optical lens offers excellent light transmittance and also durable to resist damage



③ A-class LED bead: The advanced lighting technology brings a higher Luminous Intensity, lower thermal Resistance, longer Lifespan, and a greater Luminaire Stability

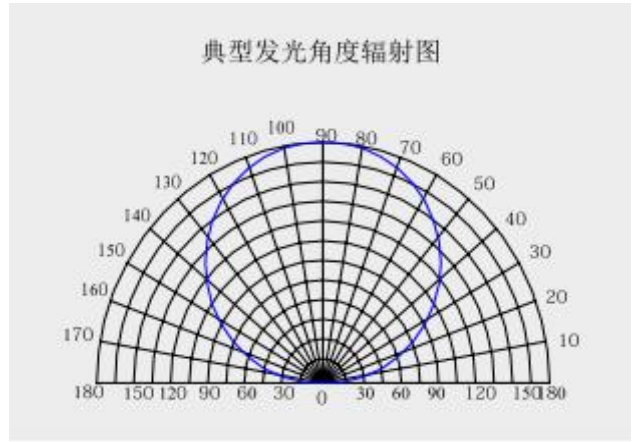
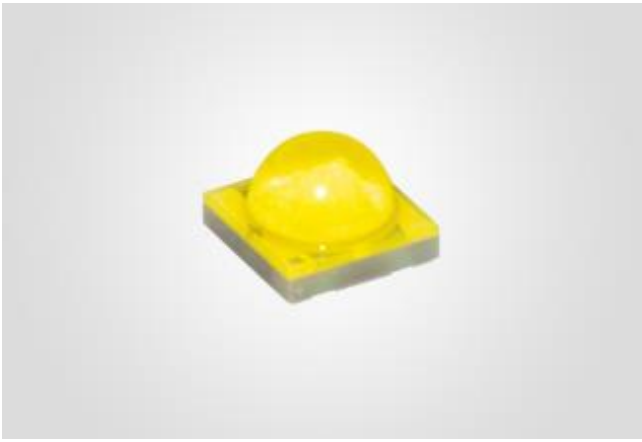

④ Patent MPPT controller developed by our R&D team, maximum power charging



⑤ Powerful lithium battery module package, lower self-discharge rate, longer lifespan, stronger depth of discharging, wider working temperature and environment-protecting



⑥ Microwave/PIR sensor

Use advanced Microwave/PIR Sensor technology, more sensitive and optimize brightness automatically. Max sensing distance is 12M. The build-in Microwave/PIR Sensor could automatically regulate brightness by identify moving object around, increase brightness when object approaches and decrease after object leaves about 20-30s (can be customized). This fluctuation of lighting intensity could preserves solar energy effectively.

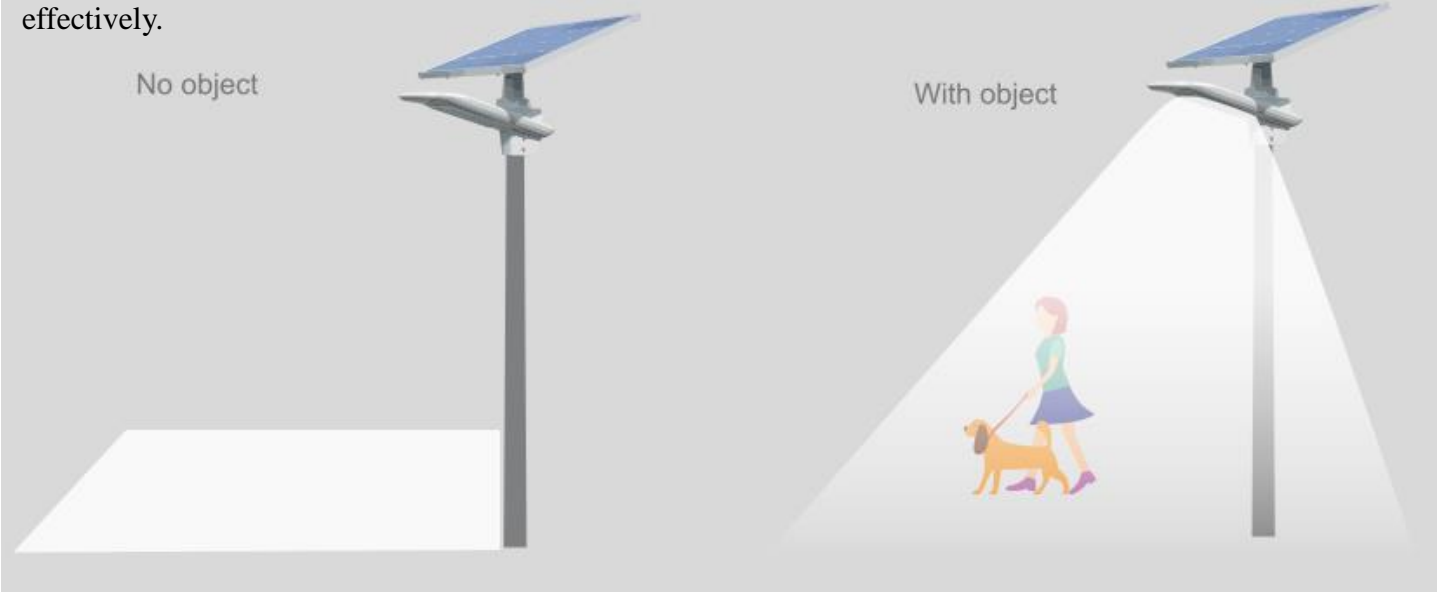

⑦ Mobile APP

The Mobile App in smartphone could be used to easily monitor and remotely control the light via the Bluetooth connection

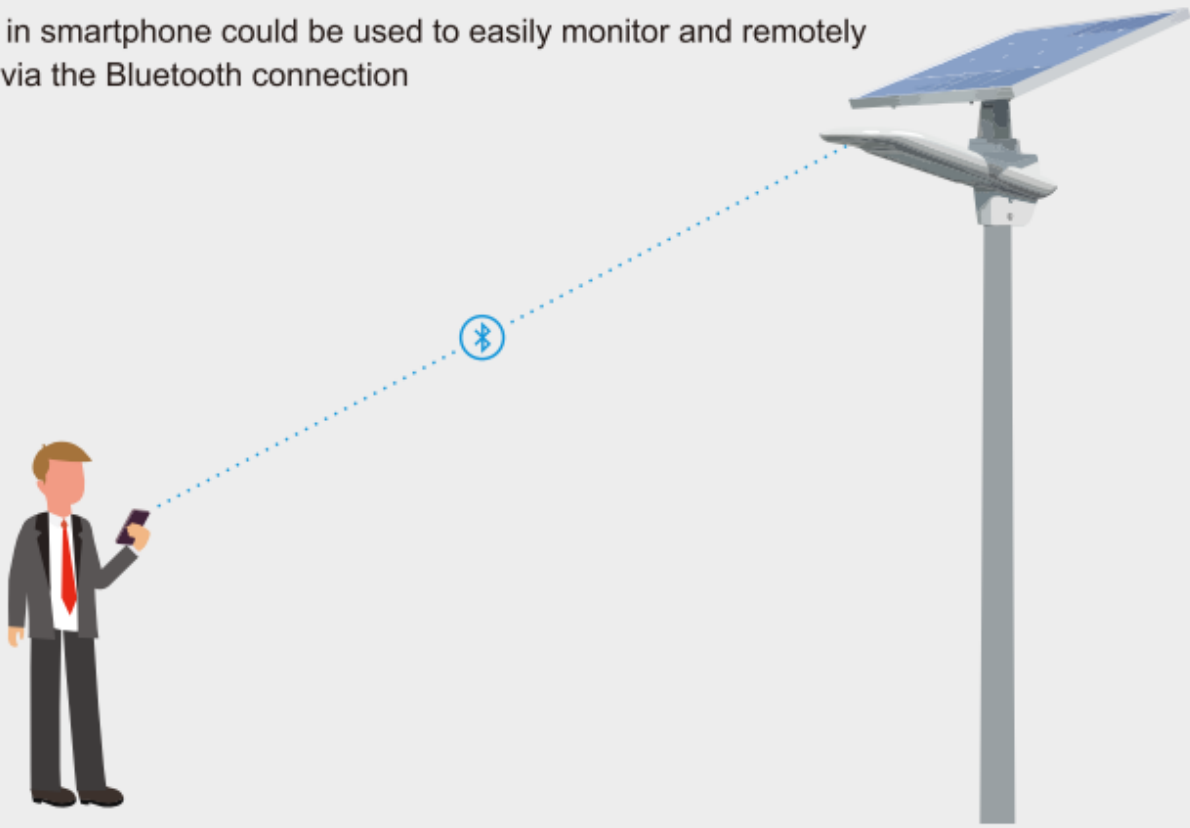

Mobile App Functionality:



APPLICATION:



Traffic Road Lighting



Industrial Estate Lighting



Open Parking Lot Lighting



Scenic Spot Lighting



Large Square Lighting



Outdoor Stadium Lighting



TECHNICAL PARAMETER:

Electrical Characteristic

Rated Power	50W
Solar Panel Power	18V 80W
Battery Capacity	341.9WH
Charge Time	6-8 H
Discharge Time	> 36H
Operating Temperature	-30 C~+60 C
Switch Threshold	15LUX
Max Sensing Distance	≤ 12M

LED Parameter

LED Beads	60 units(SMD-3535 LED)
LED Flux(LM)	6500-7500 LM
Luminous Efficiency(LM/W)	130-150LM/W
Light Distribution	Batwing Type
Color Temperature(CCT)	3000-6500K

Mechanical Specification

Light Body Size	640*260*250 MM
Solar Panel Dimension	755*670*30 MM
Installation Height	6-8 M
Pole Install Distance	20-25 M

Packing Dimension

Quantity/Carton	1 set /2 carton
Carton Size(Lamp)	690*330*320 MM
Carton Size (Panel)	800*720*75 MM
Net Weight	
Gross Weight	

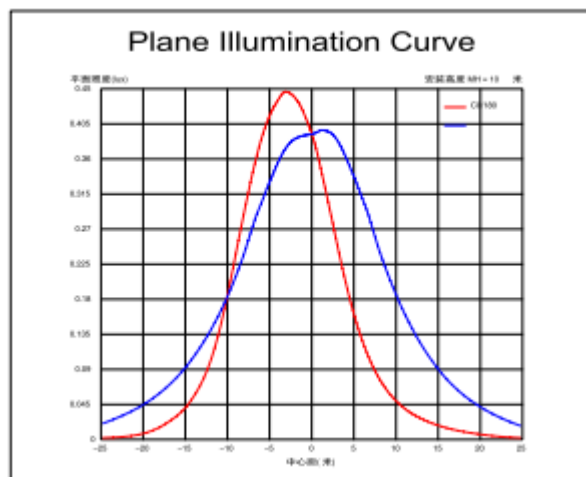
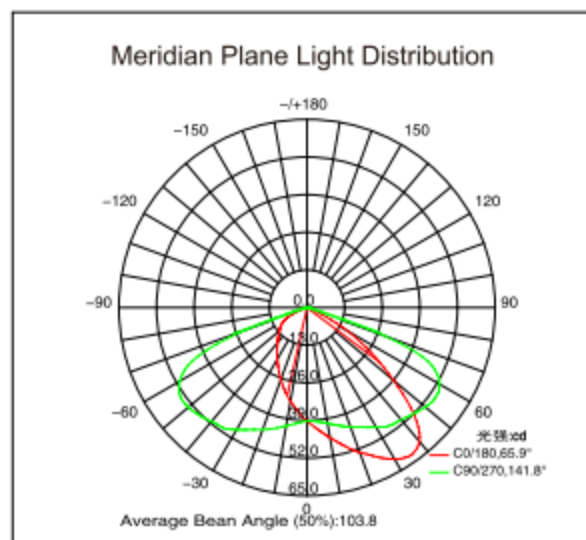
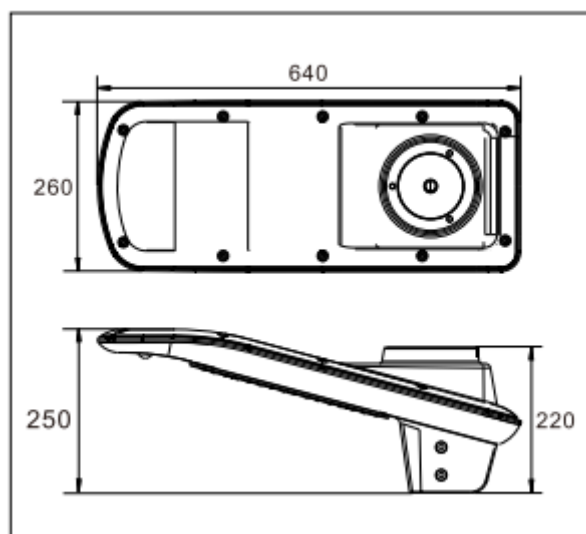

INSTALLATION INSTRUCTION:

1. Installation Diagram

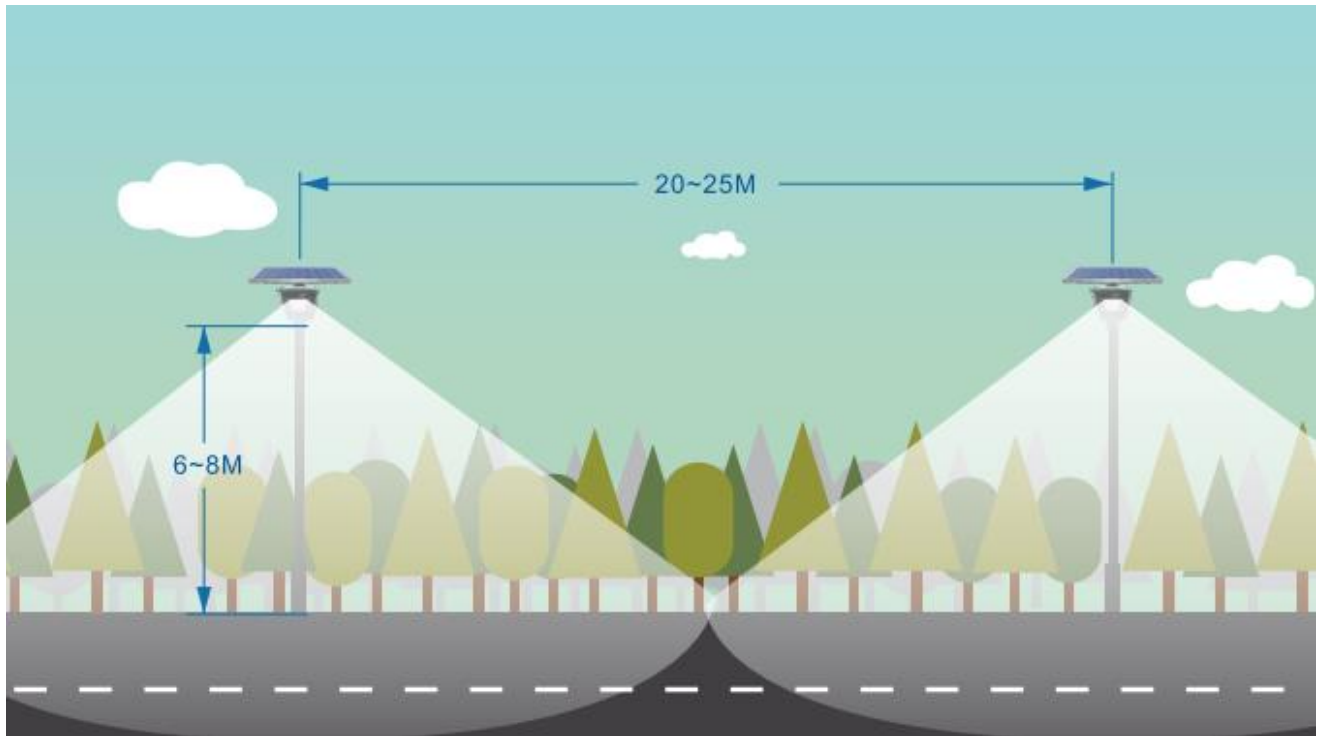

2. Packing accessories



①Solar Panel ②Light body ③Vertical bracket ④Horizontal Bracket ⑤Screws

3. Preparations before installation

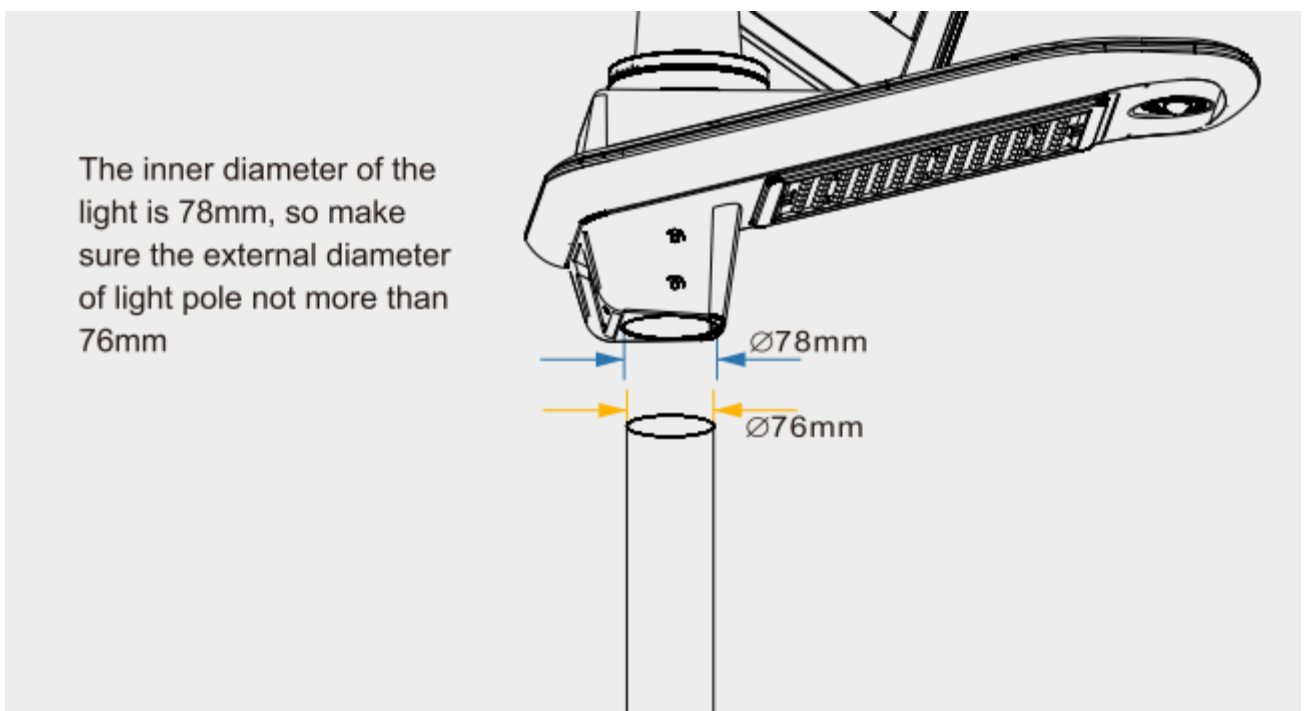

4. Installation Manual

The installation way of Solar Light is by hat socket, please check the following steps:



1. Connect the quadripuntal connectors of Horizontal Brackets & Light body together



2. Put the Horizontal Bracket on the light body and fasten the screws.



3. Fix the Vertical Bracket on the Solar Panel.



4. Mount the Vertical Bracket Module (in step 3) into the Horizontal Bracket, keep the Vertical Bracket Module backside (with 3x screws) facing toward the light, tighten the bottom screw first and then the others after adjusting the Solar Panel vertically



5. Lock the quadripuntal connectors of the Solar Panel & Horizontal Bracket together



6. Insert the assembled light module into the pole and lock the screws to secure a desired position, after adjust the best angle for maximum sunlight exposure

General Troubleshooting

Fault Symptoms	Possibility	Suggestion
Light off at night time	The solar panel is being over exposure under light sources	Remove the light sources or adjust the installation angle
	The LED panel/beads damaged	Repair or replace the LED panel/beads
	The output source open/short	Verify if the cables connection is correct
	The battery pack abnormal	1. Examine the cables connection 2. Examine if the battery pack is insufficient charged due to bad weather, which could automatically recover in sunny days
	The solar panel damaged or blocked from any obstacles	Replace the damaged components Clear obstructions or clean the panel
	The controller malfunctioned	Repair or replace the controller if damaged
Light on at daytime	The controller malfunctioned	Verify if the cables connection is correct
	The solar panel abnormal	1. Examine the cables connection 2. Clear obstructions or clean the panel 3. Replace the panel if damaged
	The cable incorrect connect	Verify the cables connection
Bluetooth disconnect	The mobile is far away the lamp	Approach the lamp
	The Bluetooth module malfunctioned	Replace the Bluetooth module
	The APP version is out-of-date	Contact assistance for correct APP version
	The cable incorrect connect	Verify the cables connection

Maintenance and Warranty

1. Maintenance

- ① Regularly clean the solar panel from dirt spots, dusting or other kinds of soiled is suggested to assure the charging efficiency
- ② Regular maintenance is suggested to keep the locking screws of pole are secured to the ground, and keep the pole clear from rust or corrosion

2. Warranty: 5 YEARS

Disclaimer Declaration:

- ① The manufacturer shall not be responsible or liable for failure to perform all or any portion of this specification due to earthquake, flood, thunder or other natural hazards, and fire disaster which not caused by The manufacturer product;
- ② The manufacturer shall not be responsible for damage and loss caused by any unforeseen events such as theft, traffic accidents ;
- ③ The manufacturer shall not be responsible for loss which not complied with this product manual;
- ④ The manufacturer shall not be responsible for loss which caused by use in conjunction with irrelevant The manufacturer products.