



SINOLTECH

Portable Solar Generator

SP3, 8W Portable DC Solar Lighting Kit

Host Specification	
Kit content	1 PCS
Built-in battery	12V 4AH
Battery type	Lead acid
Charge current	2A(max.30W)
DC output voltage	DC12V, 4PCS
USB output voltage	DC 5V/2.1A, 2PCS
Size	130*110*150mm
Weight	2 KG
Solar Panel Specification	
Kit content	1 PCS
Rated Power	8W
Rated Voltage	17.5V
Charge Current	0.45A
Dimension	350*240*18mm
Cable length	5m
LED Lamp	
Kit content	2 PCS
Rated Power	3W
Luminous Flux Output	200lm
Working time(Batttery full)	40hrs(1W), 20hrs(3W)
Cable length	5m
Size	Dia. 100*190mm
Cable & Plug	
Kit content	1 PCS
Charging plugs	10
Cable length	20 mm

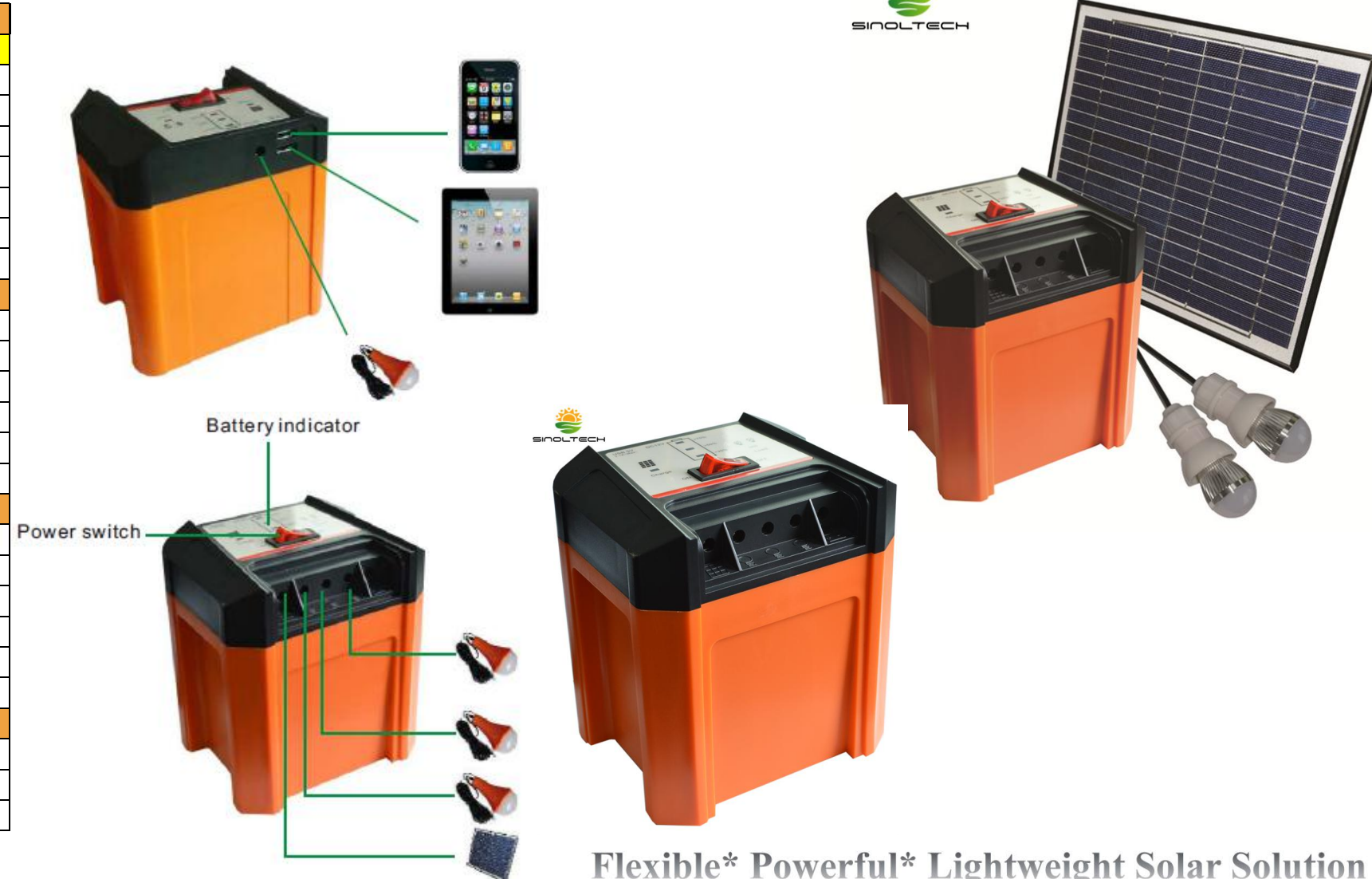

Flexible* Powerful* Lightweight Solar Solution

Portable Solar Kit SP7

SP7, 10W Portable DC Solar Generator, LED Light+USB+Radio+MP3

Host Specification	
Kit content	1 PCS
Built-in battery	12V 7AH
Battery type	Lead acid
Max. Charge current	2A
Max. discharge current(Total)	5A
DC output voltage	DC12V(3PCS)
DC Socket(Solar panel, LED light)	DC2.0mm
DC Socket(Extend battery)	DC2.5mm
USB output voltage	DC 5V/2.1A(2PCS)
Extend battery voltage	12V
Dimension	178*103*138mm
Weight	2.5 KG

Solar Panel Specification	
Kit content	1 PCS
Rated Power	10W
Rated Voltage	17.5V
Charge Current	0.56A
Dimension	350*240*18mm
Cable length	3m

LED Lamp	
Kit content	2 PCS
Rated Power	3W
Luminous Flux Output	200lm
Working time(Battery full)	40hrs(1W), 20hrs(3W)
Cable length	5m
Size	Dia. 100*190mm

FM+MP3 Function	
FM radio	1
Play U disk	1
Play SD Card	1
AUX IN	1



LED lamp



Phone charge



FM/MP3 player



Lamp Socket



status LED



Flexible* Powerful* Lightweight Solar Solution

Portable Solar Kit SP10

SP10, 10W Portable Solar DC Generator

Host Specification

Kit content	1 PCS
Built-in battery	12V 7AH
Battery type	Lead acid
Charge current	3A
DC output voltage	DC12V, 2PCS+DC5V,1PCS
USB output voltage	DC 5V/500mA, 1PCS
Size	180*130*130mm
Weight	4 KG

Solar Panel Specification

Kit content	1 PCS
Rated Power	10W
Rated Voltage	17.5V
Charge Current	0.56A
Dimension	350*240*18mm
Cable length	5m

LED Lamp

Kit content	2 PCS
Rated Power	3W
Luminous Flux Output	200lm
Working time(Battery full)	40hrs(1W), 20hrs(3W)
Cable length	3m
Size	Dia. 100*190mm

Cable & Plug

Kit content	1 PCS
Charging plugs	4
Cable length	1 m

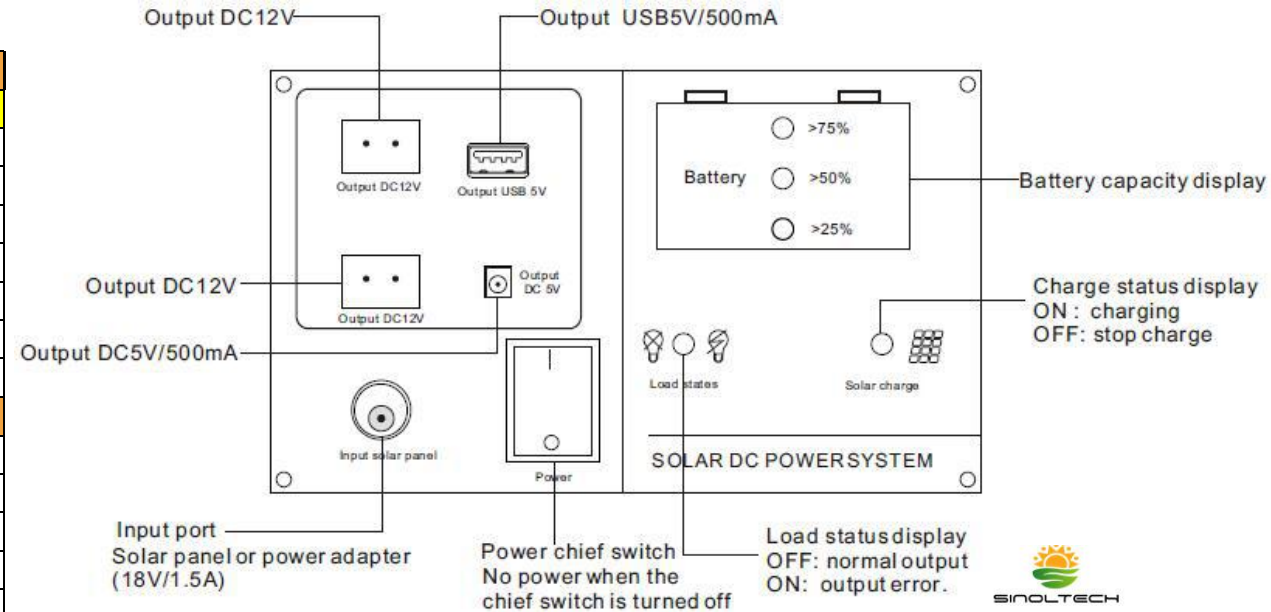

Flexible* Powerful* Lightweight Solar Solution

SP500A, 34W AC Portable Solar Generator

Technical Parameter	
System Voltage	DC 12V
Battery capacity	12V 20AH
Battery type	Lead acid
Max. Charge current	10A
Built-in solar panel power	34W(2*17W)
Open circuit voltage	17.5V
Output Voltage	DC output: 12V 5A USB output: 5V/800mA Cigar lighter:DC 12V/10A Output AC: 220V/50HZ (or customized)
Load power	DC Power<120W(total power), AC Power <500W
LVD(low-voltag disconnect)	DC load LVD: 11.0V, AC load LVD: 10.0V
DC load re-connect voltage	12.5V
HVD (High-voltage disconnect)	15.5V
Weight	15 KG
Dimension	46*34*16 CM

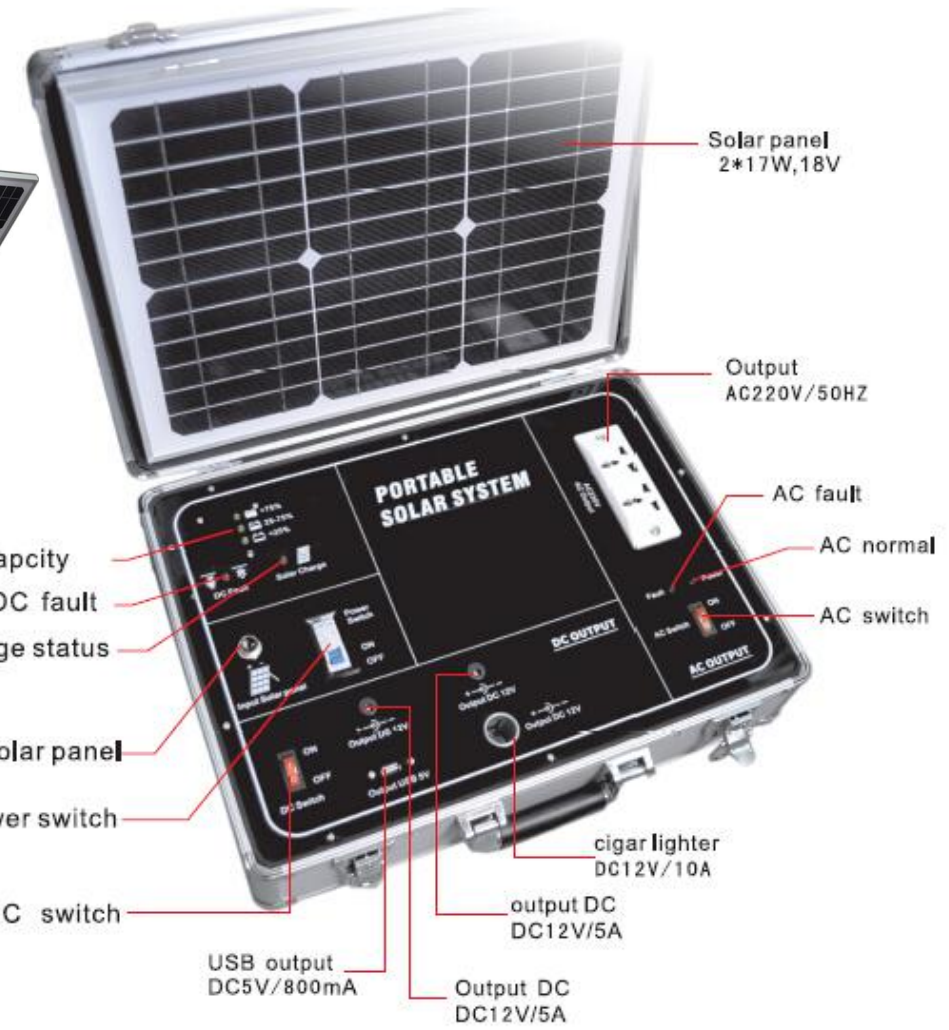

Flexible* Powerful* Lightweight Solar Solution

SP500B, 70W AC Portable Solar Generator

Technical Parameter	
System Voltage	DC 12V
Battery capacity	12V 55AH
Battery type	Lead acid
Solar Panel Power	70W 17.5V(customized)
Built-in charge controller	10A
Built-in inverter power	500W/AC220V,50HZ(customized)
Power inverter type	Modify sine wave
LED Lamp	3PCS, 3W/12V
DC Output	DC12V/5A*3PCS
AC Output	AC 220V/50HZ(customized)
Max. current of USB Port	USB 5V/800mA
Net weight	20.5 KG
Dimension	33*21*30 CM
Working temperature	-20~+50C
Protection class	IP52

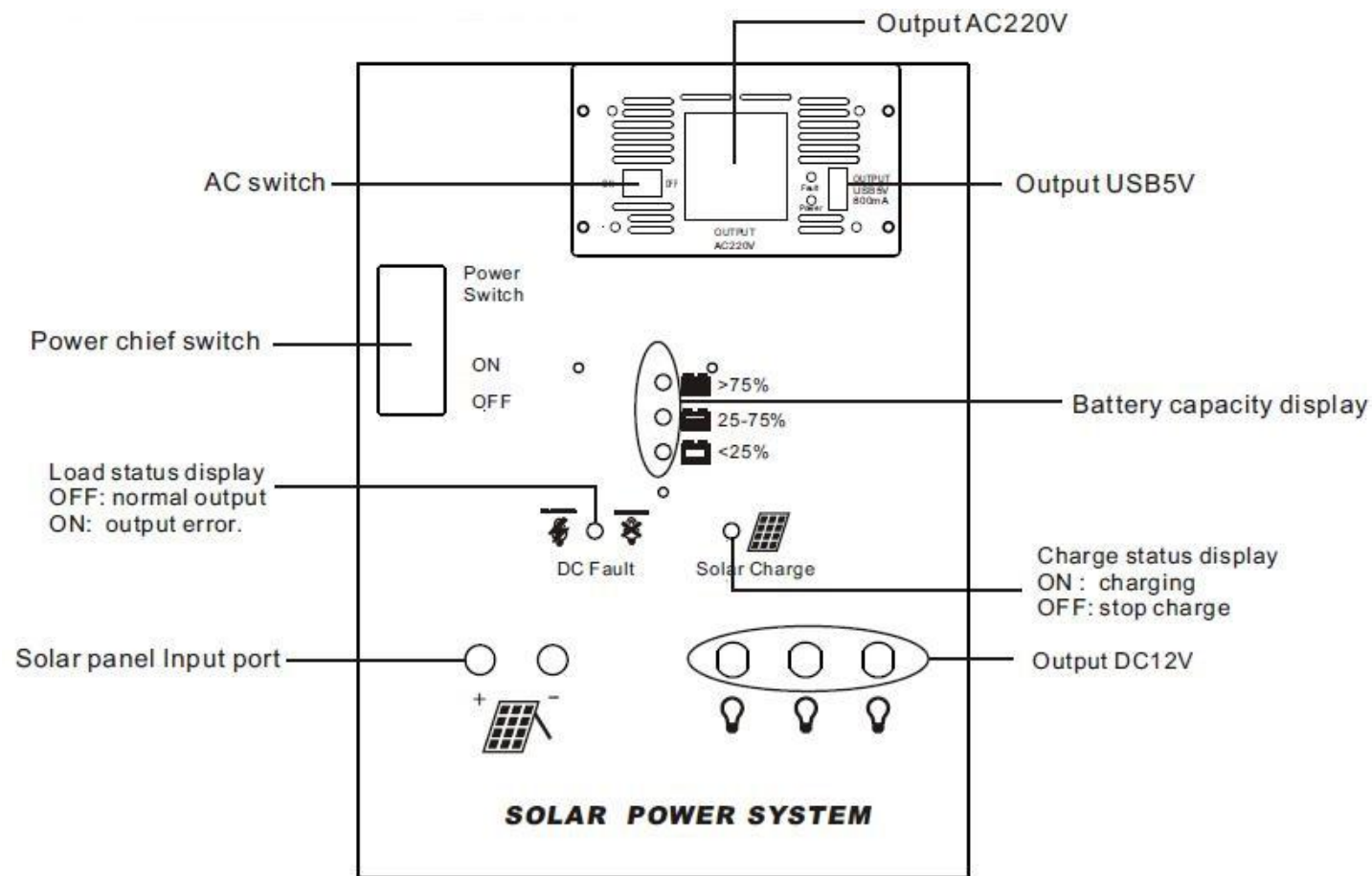

Providing custom-made services for
Power of Solar panel, capacity of battery, type of output port.

Flexible* Powerful* Lightweight Solar Solution

Portable Solar Generator 20W, built-in lithium battery

Technical Parameter	
Model No.	SN-BX-020
Solar Panel	Mono-crystalline 20W
Inverter	Pure sine wave 150W, AC100V-240V/50HZ-60HZ adjustable
Built-in battery	Polymer Lithium Battery, 12V 16Ah
Charge control	Input PWM controller 12V 8A
LED Lamp	Built-in 3W LED light
AC Output	AC 110V-240V*1PCS
DC Output	DC 12V*2PCS
USB Output	USB 5V *1PCS
Cigar Lighter	1 PCS
Function	ABS material, with LED status indicator.
	IP65 Rain-proof design and UPS function;
	Light weight, high portability;
Charging time by sunshine	16-18 hours
Working hours	1.5 hours for 150W equipment
Product size	397*316*106mm
Net weight	5.8 KG
Packing Detail	Carton size:450*450*385mm;3pcs per carton;
	Carton weight:24kg; 20" GP: 600-720pcs; 40" GP: 1200-2000pcs.

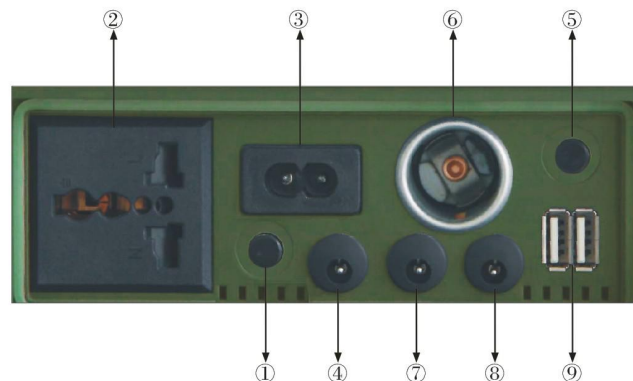

- ① AC ON/OFF
- ② 100~240V AC OUTPUT
- ③ 100~240V AC INPUT
- ④ 12V~23V DC INPUT
- ⑤ DC ON/OFF
- ⑥ 12V CAR SOCKET
- ⑦ 12V DC OUTPUT(5.5*2.5mm)
- ⑧ 12V DC OUTPUT(5.5*2.5mm)
- ⑨ 5V USB

Flexible* Powerful* Lightweight Solar Solution

Portable Solar Generator 50W, built-in lithium battery

Technical Parameter	
Model No.	SN-BX-050
Solar Panel	Mono-crystalline 50W
Inverter	Pure sine wave 350W, AC100V-240V/50HZ-60HZ adjustable
Built-in battery	Polymer Lithium Battery, 12V 48Ah
Charge control	Input PWM controller 12V 8A
LED Lamp	Built-in 3W LED light
AC Output	AC 110V-240V*1PCS
DC Output	DC 12V*2PCS
USB Output	USB 5V *1PCS
Cigar Lighter	1 PCS
Function	ABS material, with LED status indicator.
	IP65 Rain-proof design and UPS function;
	Light weight, high portability;
Charging time by sunshine	20-22 hours
Working hours	3.8 hours for 150W equipment
Product size	442*345*145mm
Net weight	8.5 KG
Packing detail	Carton size: 550*445*430mm; 2pcs per carton; Carton weight: 25kg; 20" GP: 360-400pcs; 40" GP: 720-840pcs.

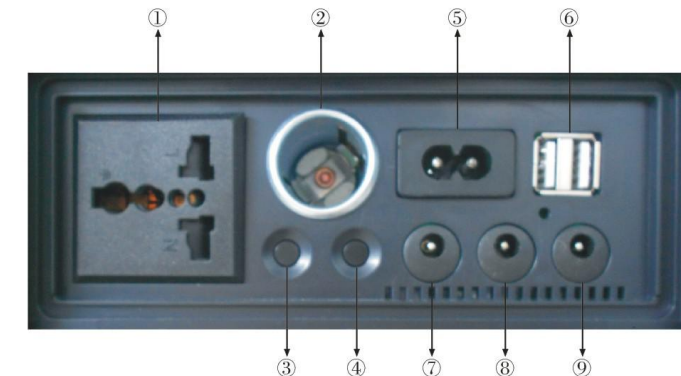

- ① 100~240V AC OUTPUT
- ② 12V CAR SOCKET OUTPUT
- ③ AC ON/OFF
- ④ DC ON/OFF
- ⑤ 100~240V AC INPUT
- ⑥ 5V USB
- ⑦ 12V~23V DC INPUT
- ⑧ 12V DC OUTPUT(5.5*2.5mm)
- ⑨ 12V DC OUTPUT(5.5*2.5mm)

Flexible* Powerful* Lightweight Solar Solution

Flexible* Powerful* Lightweight Solar Solution

SINOLTECH®

Military Standard 55W

Portable Solar Kit



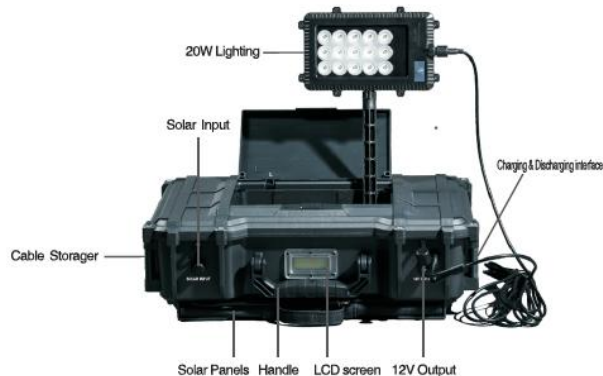

Portable Solar Generator 55W, built-in lithium battery





Technical Parameter	
Model No.	SN-BX-055
Solar Panel	Mono-crystalline 55W
Inverter	Pure sine wave 350W, AC100V-240V/50HZ-60HZ adjustable
Built-in battery	Polymer Lithium Battery, 12V 48Ah
Charge control	Input PWM controller 12V 8A
LED Lamp	20W LED light, and a built-in 3W LED light
AC Output	AC 110V-240V*1PCS
DC Output	DC 12V*2PCS
USB Output	USB 5V *1PCS
Cigar Lighter	1 PCS
LED Lamp	Built-in 3W led light
Function	ABS material, with LED status indicator.
	IP65 Rain-proof design and UPS function; Light weight, high portability;
Charging time by sunshine	20-22 hours
Working hours	3.6 hours for 150W equipment
Product size	442*345*145mm
Net weight	10.5 KG
Packing detail	Carton size: 550*445*430mm; 2pcs per carton; Carton weight: 25kg; 20" GP: 360-400pcs; 40" GP: 720-840pcs.



Flexible* Powerful* Lightweight Solar Solution

Portable Solar Lighting Kit 10W & 20W

Technical Parameter		
Model No.	SL52-10	
Solar Panel	18V10W solar panel, unfoldable; Stainless brackets with adjustable angle at 30degree, 60degree, 90degree and 120degree; With waterproof cable;	
Solar LED Tube	Waterproof and Remote Controlled LED Tube Light; Brightness: 1000lumens, High/medium/low brightness modes; Lithium battery 2pcs*4series 14.8V4400mAh; 8-9hours working at high mode; Charging time: 5-6hours by sunshine; With remote controller;	
Bag	Carrying bag for the solar panel Carrying bag for the LED tube;	
AC Adapter	19V-2A AD-DC Adapter, with all necessary certifications including: CE, RoHS, SAA, TUV, UL etc. (Optional)	
Car Adapter	19V Car Adapter, for charging this tube from the car/truck etc. (Optional)	

Technical Parameter		
Model No.	SL52-20	
Solar Panel	18V20W folding solar panel, Stainless brackets with adjustable angle at 30degree, 60degree, 90degree and 120degree; With waterproof cable;	
Solar LED Tube	Waterproof and Remote Controlled LED Tube Light; Brightness: 1000lumens, High/medium/low brightness modes; Lithium battery 2pcs*4series 14.8V4400mAh; 8-9hours working at high mode; Charging time: 5-6hours by sunshine; With remote controller;	
Bag	Carrying bag for the solar panel Carrying bag for the LED tube;	
AC Adapter	19V-2A AD-DC Adapter, with all necessary certifications including: CE, RoHS, SAA, TUV, UL etc. (Optional)	
Car Adapter	19V Car Adapter, for charging this tube from the car/truck etc. (Optional)	



SINOLTECH ENERGY LIMITED
SHANDONG SINOLTECH INTERNATIONAL CO., LTD



Contact Us:

SINOLTECH ENERGY LIMITED

Shandong Sinoltech International Co., Ltd

TEL: +86-15318807707

FAX: 0086-531-88894033

**Address: A1-3-712, EAST 8 ENTERPRISE MANSION, DESIGN & CREATIVE
INDUSTRIAL AREA, JINAN, CHINA POST CODE: 250100**

Email: Susan@sinoltech.com / Sinoltech@hotmail.com

SKYPE: Sinoltech

Website: www.sinoltech.com